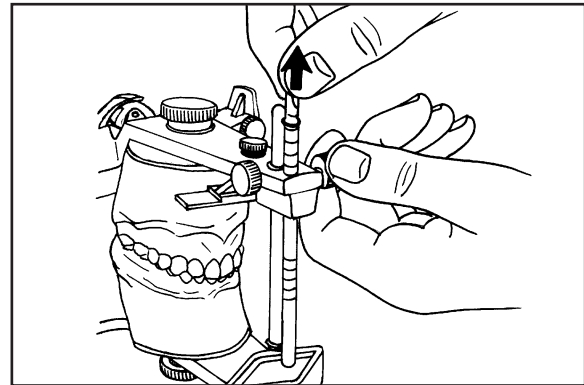
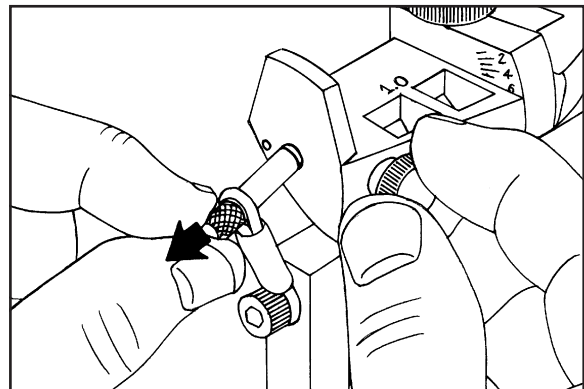

Analog Selector Instructions

Raise and lock incisal pin (arrow) at least 5mm above table in preparation for using analog selectors.

**1**

Loosen analog thumb screws and retract right and left Dyna-Link pins (arrow).

**2**

Place Dyna-Link pins in storage holes in articulator legs (arrow).

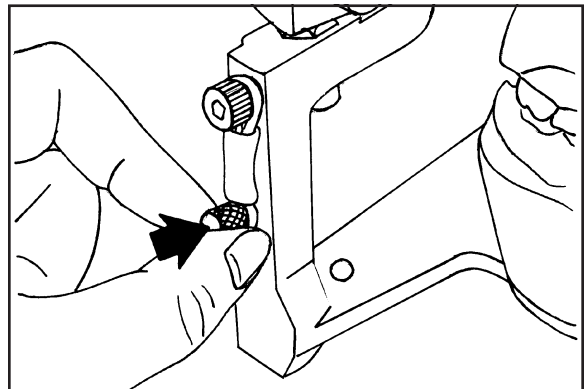
**3**

Release centric latch. Be sure centric pin springs upward to disengaged centric channel.

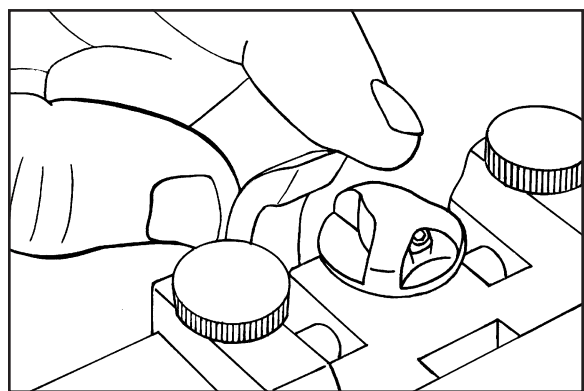
**4**

5

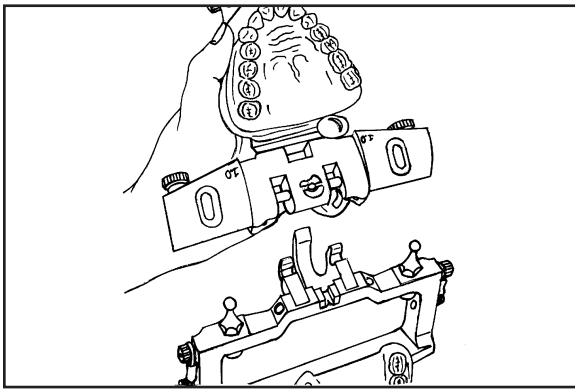

Separate frames of articulator.

6

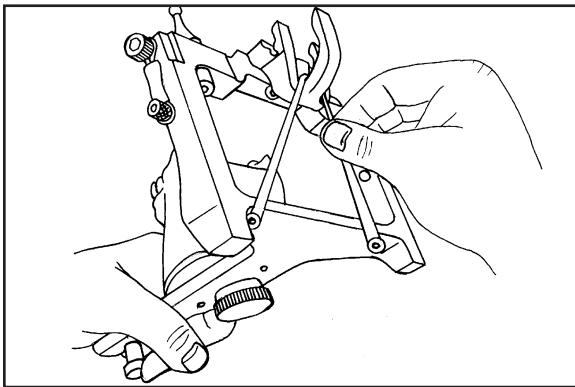

Place centric latch hold down (elastic band) to hold latch in downward position.

7

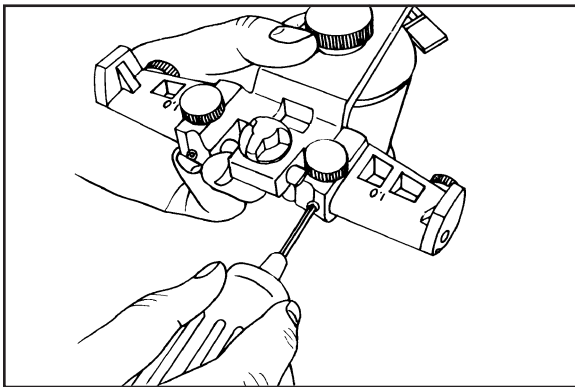

Loosen right and left analog shaft set screws with hex wrench.

8

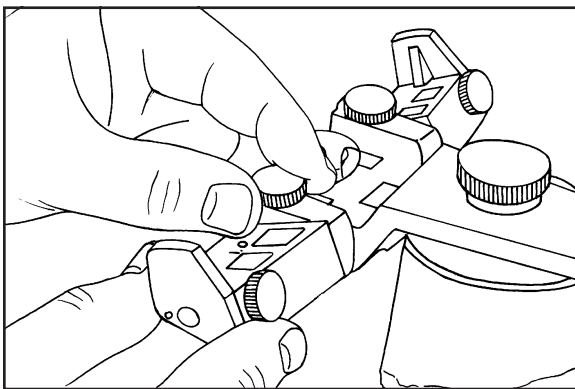

Loosen right and left analog shaft thumb screws.

Remove both motion analogs by pulling laterally (arrow).

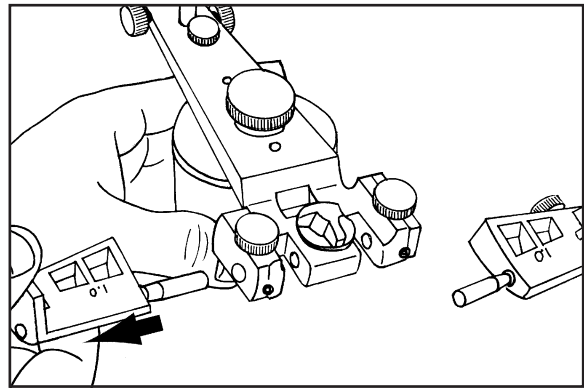

9

Right and left analog selectors are marked respectively with letters "R" and "L".

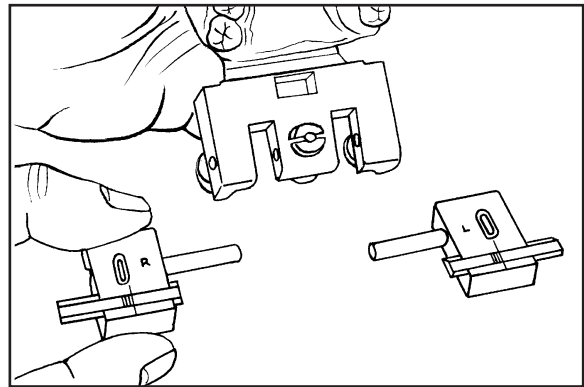

10

Insert axis shaft of right side analog selector into transverse axis hole in maxillary frame of articulator. Rotate to highest position ("0") and lock with thumb screw. Be sure selector is in contact with calibrated side of articulator (small arrow).

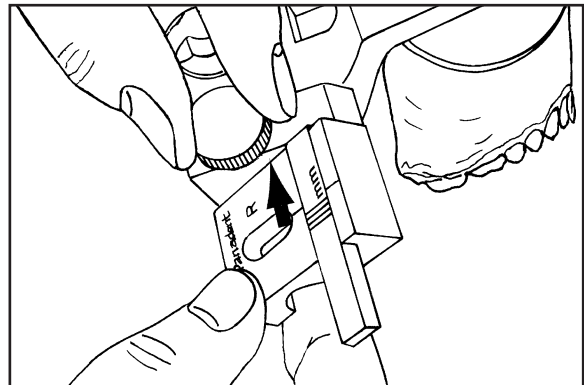

11

Use left lateral positional record when using right side selector (note arrows).

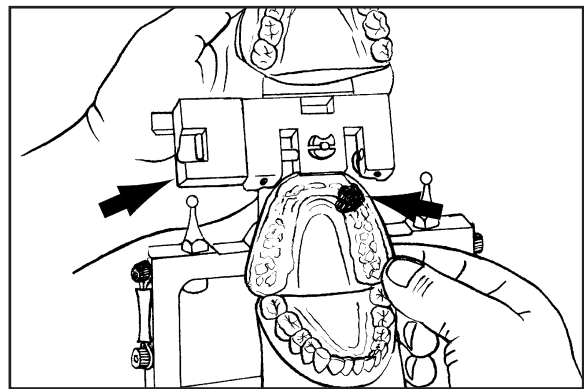

12

13

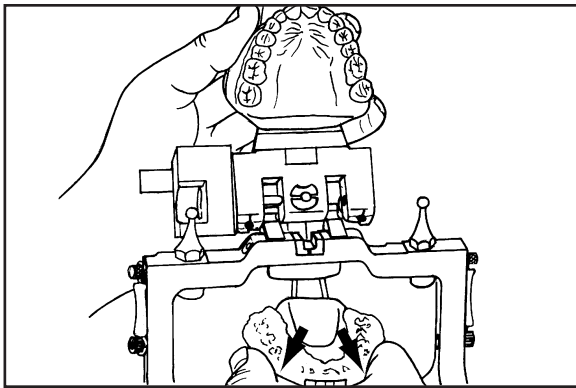

Fit left lateral positional record onto occlusal surface of mandibular cast (arrows).

14

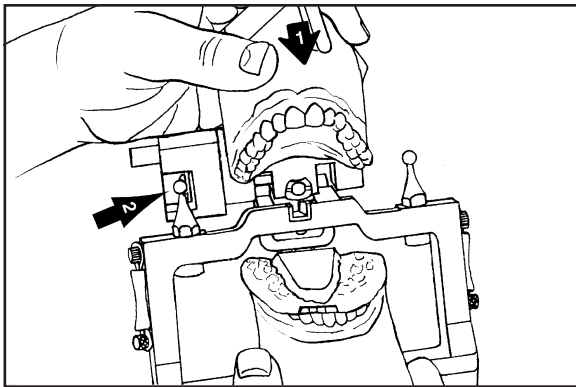

Hold maxillary cast directly over occlusal record (arrow #1) with right side condyle element positioned in selector guide opening (arrow #2).

15

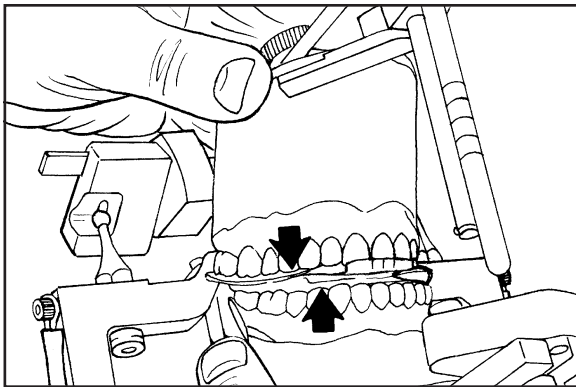

Fit maxillary cast carefully into occlusal record (arrows).

16

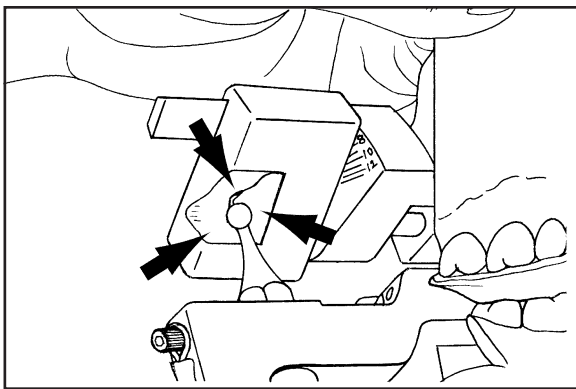

There should be space between condylar element and all three walls of analog selector (arrows).

A close view showing space between condylar element and superior and posterior walls of selector.

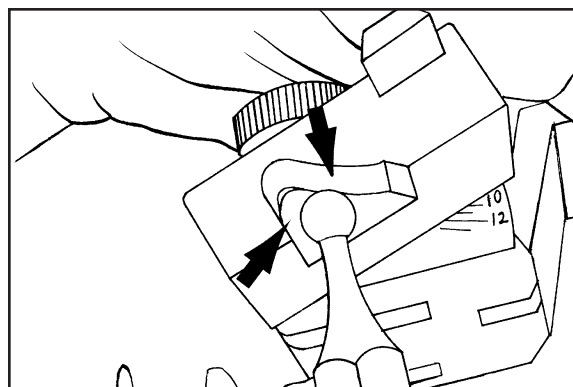

17

Set articulator on counter top. With one hand press firmly downward on casts (large arrow) to seat them into occlusal record. While pressing downward, loosen selector thumb screw and allow selector to rotate downward to contact condyle element (curved arrow).

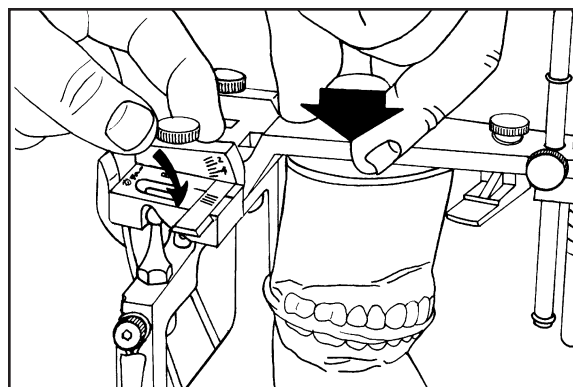

18

When thumb screw is released, selector will "drop" downward to contact superior surface of condylar element (arrow).

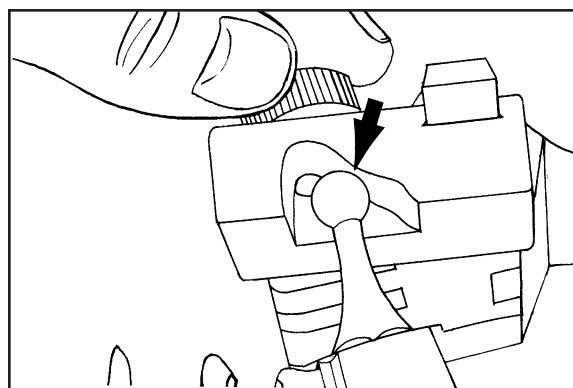

19

While thumb screw is still loose, pull laterally on selector (large arrows) to contact medial side of condylar element (small arrow).

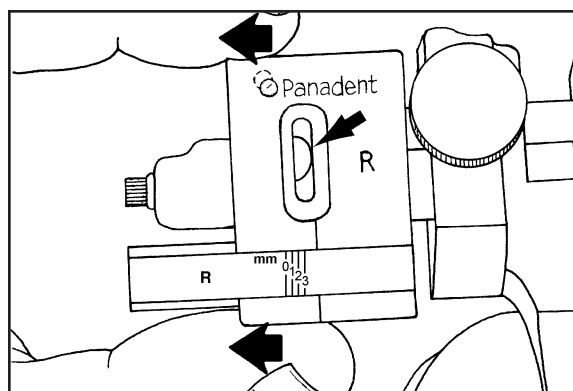

20

21

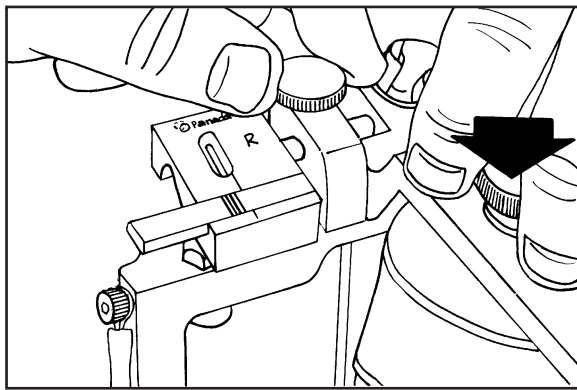

Continue to press firmly downward on casts (large arrow) while tightening selector thumb screw.

22

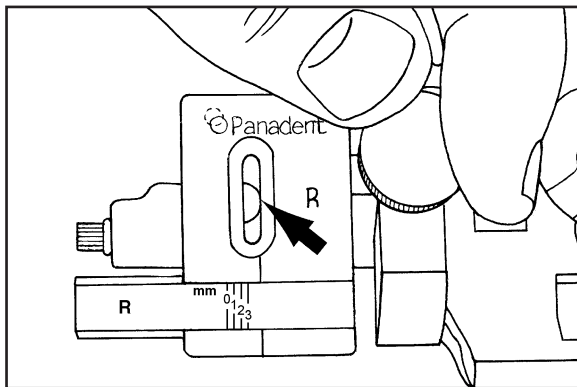

Close view showing selector locked in position against condylar element (arrow).

23

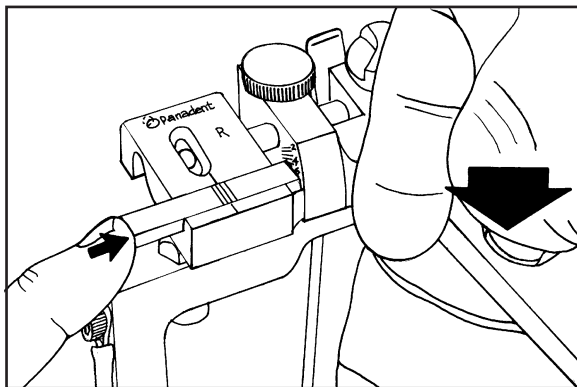

While continuing to press on casts (large arrow), push Bennett scale medially (small arrow) until it touches calibrated side of the articulator.

24

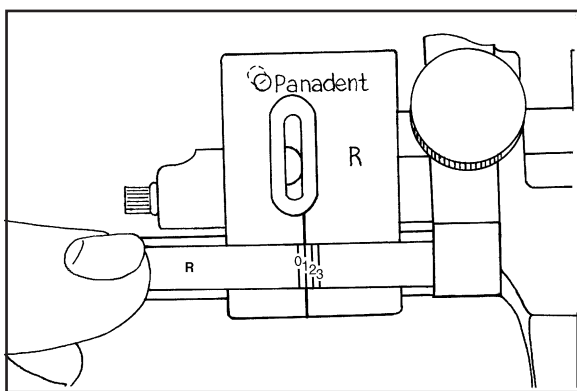

The amount of Bennett movement is read in millimeters on scale. This patient has 1mm of Bennett and therefore a 1mm preformed analog would be used on this side to guide the articulator. If reading is slightly more than line, use next size analog. Panadent Motion Analogs are produced in a series of five sizes as follows: 0.5, 1.0, 1.5, 2.0, 2.5mm.

Separate articulator frames. Remove positional record and right side selector.

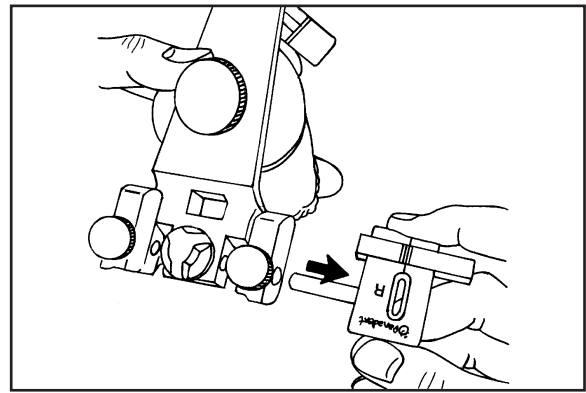

25

Place left side selector tightly against calibrated side of articulator (small arrow). Lock selector with thumbscrew in "0" upward position.

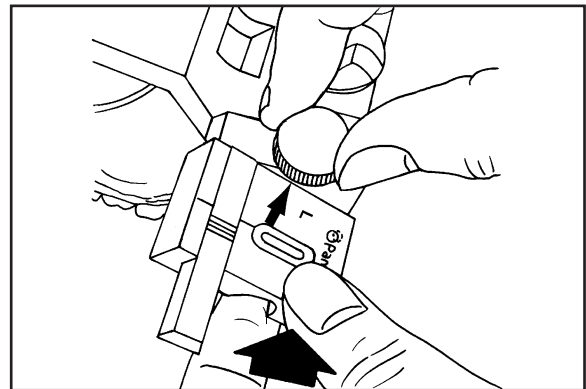

26

Change to right lateral positional record when using left side selector (arrows).

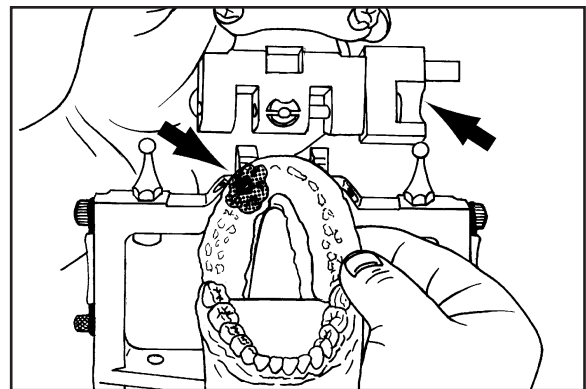

27

Fit right lateral positional record onto occlusal surface of mandibular cast (arrows).

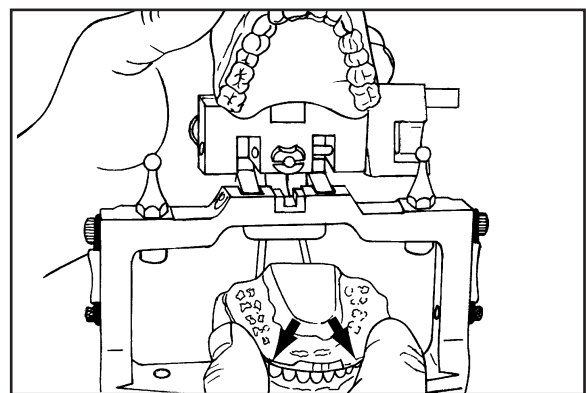

28

29

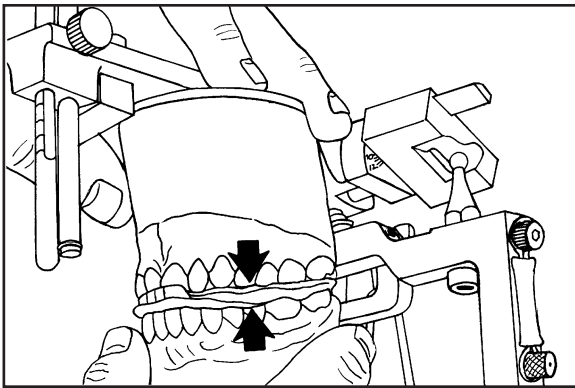

Place analog selector over left condylar element. Gently fit teeth of maxillary cast into record (arrows).

30

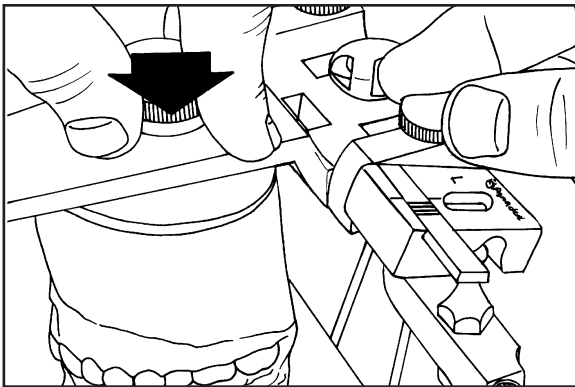

Set articulator on table top. Press firmly downward with one hand to seat cast into occlusal record (large arrow).

31

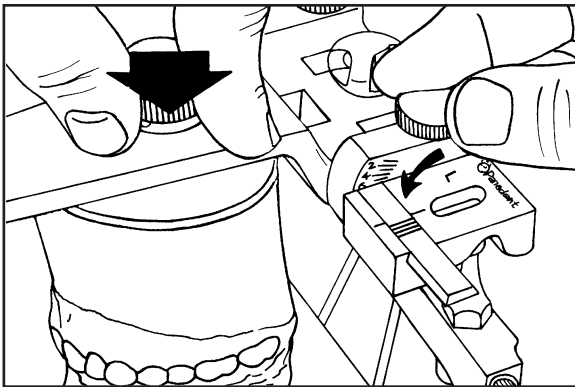

While continuing downward pressure (large arrow) loosen selector thumb screw to allow selector to "drop" (rotate) downward to contact condylar element (small arrow).

32

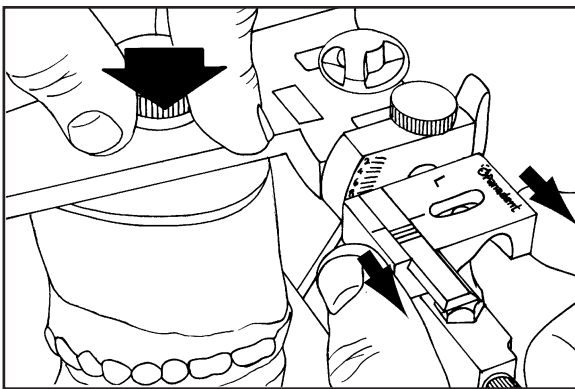

While thumb screw is still loose, pull selector laterally (arrows) to contact medial side of condyle element.

Keep heavy downward pressure on cast (large arrow). Lock thumb screw to maintain vertical and horizontal position of selector.

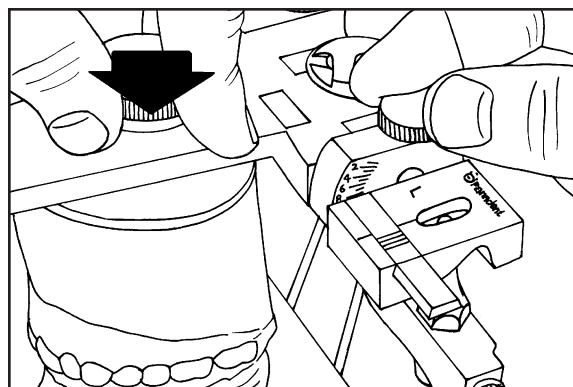

33

Push Bennett scale medially (small arrow) to contact calibrated side of articulator .

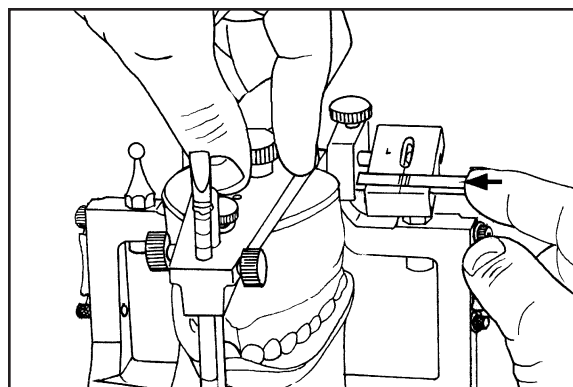

34

Lateral view showing BENNETT SCALE touching side of articulator - DO NOT take angular reading with lateral check-bite.

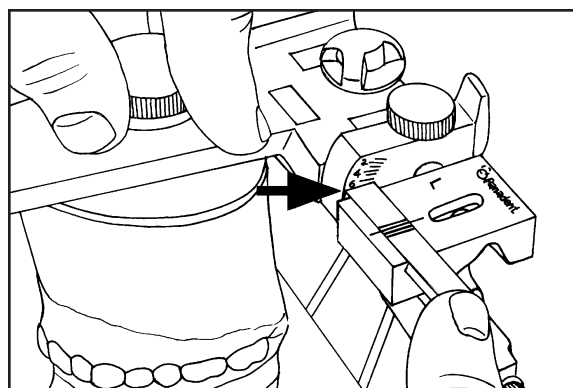

35

Note proper position of condylar element (arrow #1) and end of Bennett scale when reading is made (arrow #2). Amount of Bennett movement is read in millimeters on scale. This patient has 2mm of Bennett and therefore a 2mm preformed analog is indicated. If reading exceeds a mm line, make reading to next larger mm position for choosing preformed analog.

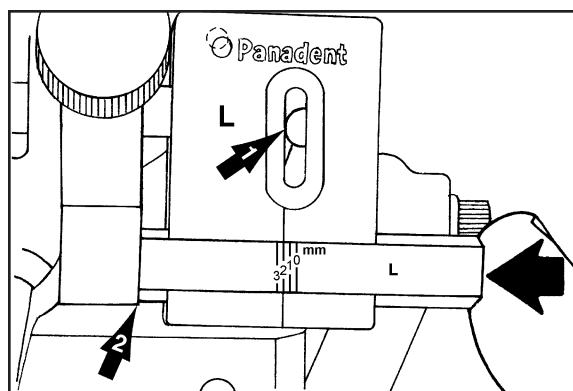

36

37

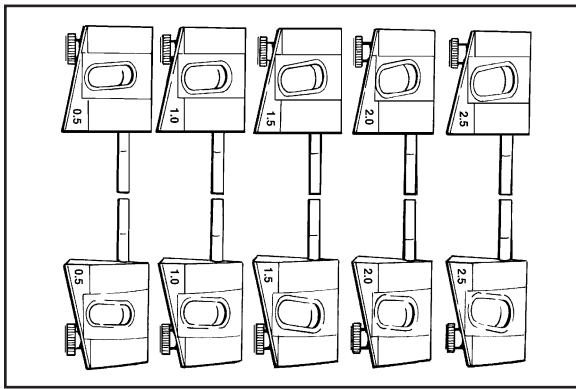

A complete set of Panadent preformed condylar axis motion analogs starting with .5mm Bennett curvature on the left and increasing to 2.5mm on the right in .5mm increments. The analogs may be mixed, thus allowing for different sizes between right and left sides.

38

Distribution of Bennett Movement
OPERATOR INDUCED

Millimeters per side *	.25	.5	1	1.5	2	2.5
Percent (%) of Patients	2	15	52	21	8	2

* Rt. & Lt. border movements measured on the non-working side 3mm forward on the vertical and horizontal planes from centric relation.

Distribution chart for the amounts of Bennett movement taken from patient's motion analogs recorded with the Lee Research Axiopantagraph.

39

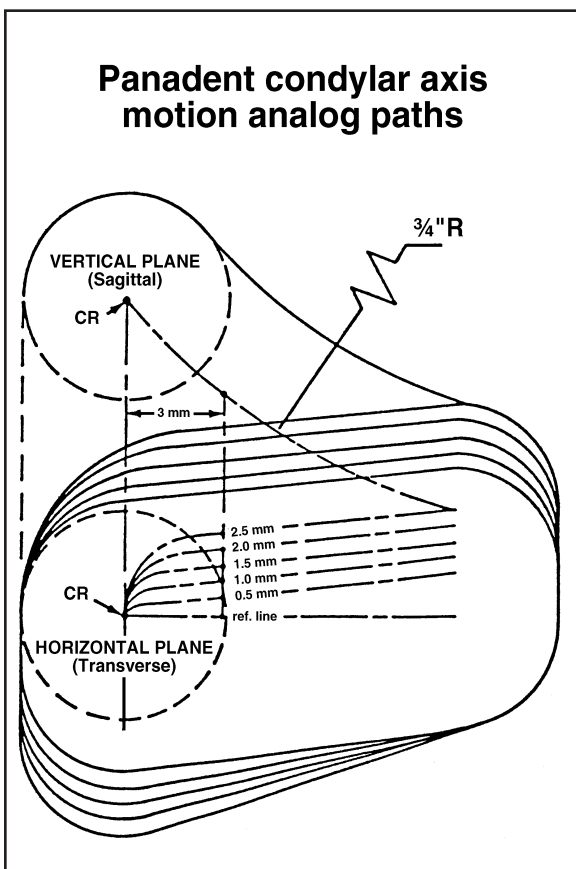

Schematic of Panadent preformed Motion Analogs. Note the variations in the curved Bennett paths in the functional range of 3mm from centric relation. The paths beyond the 3mm point are of no significance in lateral function. The frontal plane paths are not shown in the illustration (for simplicity) but curvatures are essentially the same as the horizontal plane.

